

4K Mini Fixed Bullet Network Camera

IPC2128LE-ADF28(40)KM-G



Key Features



- High quality image with 8MP, 1/2.7"CMOS sensor
- 8MP (3840*2160)@20fps; 5MP (3072*1728)@30/25fps; 4MP (2560*1440)@30/25fps; 2MP (1920*1080) @30/25fps
- Ultra 265, H.265, H.264, MJPEG
- EasyStar technology ensures high image quality in low illumination environment
- 120dB true WDR technology enables clear image in strong light scene
- Support 9:16 Corridor Mode
- Built-in Mic
- Smart IR, up to 50m (164ft) IR distance
- Supports 256 G Micro SD card
- IP67 protection
- Support PoE power supply
- 3-Axis

Specifications

	IPC2128LE-ADF28KM-G	IPC2128LE-ADF40KM-G			
Camera					
Sensor	1/2.7", 8.0 megapixel, progressive scan, CMOS				
Minimum Illumination	Support Easystar: Colour: 0.005 lux (F1.6, AGC ON) 0Lux with IR on				
Day/Night	IR-cut filter with auto switch (ICR)				
Shutter	Auto/Manual, 1~1/100000 s				
Adjustment angle	Pan: 0° ~ 360°	Tilt: 0° ~ 90°	Rotate: 0° ~ 360°		
S/N	>56dB				
WDR	120dB				
Lens					
Lens Type	2.8mm @F1.6	4.0mm @1.6			
Iris	Fixed				
Field of View (H)	98.3°	91.2°			
Field of View (V)	53.3°	47.9°			
Field of View (D)	103.1°	95.9°			
DORI					
DORI Distance	Lens	Detect(m)	Observe(m)	Recognize(m)	Identify(m)
	2.8mm	84	33.6	16.8	8.4
	4.0mm	120	48	24	12
Illuminator					
IR Range	Up to 50m (164 ft) IR range				
Wavelength	850nm				
IR On/Off Control	Auto/Manual				
Video					
Video Compression	Ultra 265, H.265, H.264, MJPEG				
H.264 code profile	Baseline Profile, Main Profile, High Profile				
Frame Rate	Main Stream: 8MP (3840*2160), Max 20fps; 5MP (3072*1728), Max 30fps; 4MP (2560*1440), Max 30fps; 1080P (1920*1080), Max 30fps; Sub Stream: 1080P (1920*1080), Max 30fps; 720P (1280*720), Max 30fps; D1 (720*576), Max 30fps; 640*360, Max 30fps; 2CIF(704*288), Max 30fps; CIF(352*288), Max 30fps;				
Video Bit Rate	128 Kbps~16 Mbps				
U-code	Support				
OSD	Up to 4 OSDs				
Privacy Mask	Up to 4 areas				
ROI	Up to 8 areas				
Video stream	Dual streams				
Image					
White Balance	Auto/Outdoor/Fine Tune/Sodium Lamp/Locked/Auto2				
Digital noise reduction	2D/3D DNR				
Smart IR	Support				
Flip	Normal/Vertical/Horizontal/180°/90°Clockwise/90°Anti-clockwise				
HLC	Supported				

BLC	Supported
Defog	Digital Defog
Events	
Basic Detection	Cross line, intrusion(based on human body detection),motion detection, Ultra motion detection, tampering alarm, audio detection
General Function	Watermark, IP address filtering, access policy, ARP protection, RTSP authentication, user authentication, HTTP authentication
Audio	
Audio Compression	G.711U, G.711A
Audio Bitrate	64 Kbps
Two-way Audio	N/A
Suppression	Supported
Sampling Rate	8KHZ
Storage	
Edge Storage	Micro SD, up to 256GB
Network Storage	ANR, NAS(NFS)
Network	
Protocols	IPv4, IPv6, IGMP, ICMP, ARP, TCP, UDP, DHCP, RTP, RTSP, RTCP, DNS, DDNS, NTP, FTP, UPnP, HTTP, HTTPS, SMTP, SSL/TLS, QoS, 802.1x, SNMP
Compatible Integration	ONVIF (Profile S, Profile G, Profile T), API, SDK
User/Host	Up to 32 users. 2 user levels: administrator and common user
Security	Password protection, Strong password, HTTPS encryption, Export operation logs, Basic and digest authentication for RTSP, Digest authentication for HTTP, TLS 1.2, WSSE and digest authentication for ONVIF
Client	EZStation EZView EZLive
Web Browser	Plug-in required live view: IE 10 and above, Chrome 45 and above, Firefox 52 and above, Edge 79 and above
	Plug-in free live view: Chrome 57.0 and above, Firefox 58.0 and above, Edge 16 and above
Interface	
Audio I/O	N/A
Alarm I/O	N/A
Serial Port	N/A
Built-in Mic	Support
Built-in Speaker	N/A
WIFI	N/A
Network	1 * RJ45 10M/100M Base-TX Ethernet
Video Output	N/A
Certification	
EMC	CE-EMC (EN 55032: 2015+A1:2020,EN 61000-3-3: 2013+A1: 2019,EN IEC 61000-3-2: 2019+A1: 2021,EN 55035: 2017+A11:2020) FCC (FCC CFR 47 part15 B, ANSI C63.4-2014)
Safety	CE LVD (EN 62368-1:2014+A11:2017) CB (IEC 62368-1:2014) UL (UL 62368-1, 2nd Ed., Issue Date: 2014-12-01)
Environment	CE-RoHS (2011/65/EU;(EU)2015/863); WEEE (2012/19/EU); Reach (Regulation (EC) No 1907/2006)
Protection	IP67 (IEC 60529:1989+AMD1:1999+AMD2:2013)

General	
Power	12 V DC±25%, PoE (IEEE802.3 af)
	Power consumption: Max 6.5W
Power Interface	Ø 5.5mm coaxial power plug
Dimensions (L × W × H)	190×73×71mm (7.5"×2.9"×2.8")
Weight	0.45kg (0.99lb)
Working Environment	-30°C ~ +60°C (-22°F ~ 140°F), Humidity: ≤95% RH(non-condensing)
Storage Environment	-30°C ~ +60°C (-22°F ~ 140°F), Humidity: ≤95% RH(non-condensing)
Surge Protection	4KV
Reset Button	Support

Dimensions

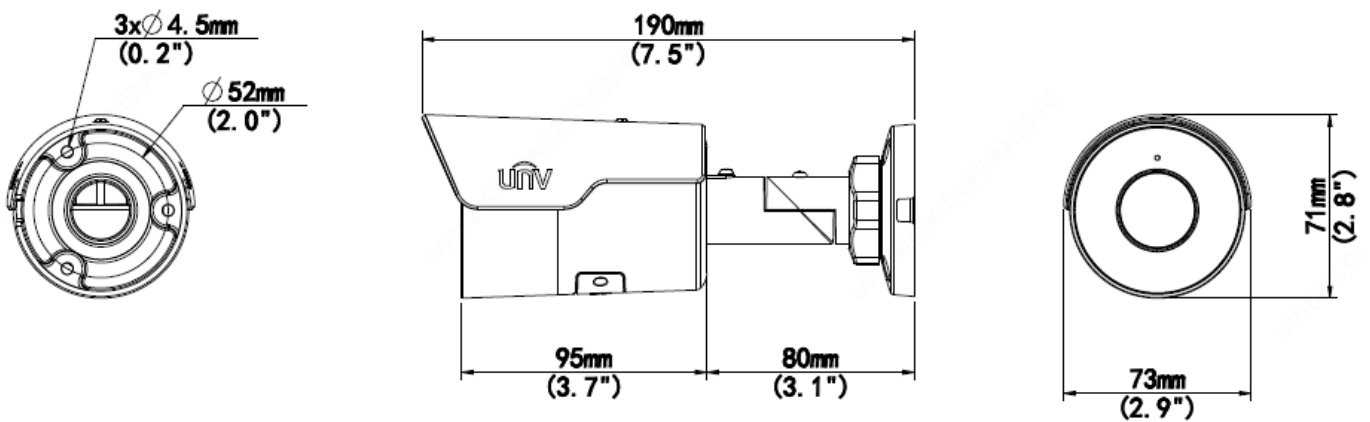

Accessories

TR-JB05-B-IN
Junction Box



TR-UP06-C-IN
Pole Mount



TR-A01-IN
Waterproof Joint



Zhejiang Uniview Technologies Co., Ltd.

Building No.10, Wanlun Science Park, Jiangling Road 88, Binjiang District, Hangzhou, Zhejiang, China (310051)

Email: overseasbusiness@uniview.com; globalsupport@uniview.com

<http://www.uniview.com>

©2021-2022 Zhejiang Uniview Technologies Co., Ltd. All rights reserved.

*Product specifications and availability are subject to change without notice.